

INSTRUCTION MANUAL

SIL 2 Temperature Signal Converter
Multifunction, Trip Amplifiers,
DIN-Rail and Termination Board,
Models D6273S



Characteristics

General Description: The single channel Temperature Signal Converter, Trip amplifiers D6273S accepts a low level dc signal from millivolt, thermocouple or 2-3-4 wire RTD or transmitting potentiometer sensors and converts, with isolation, the signal to drive a load, suitable for applications requiring SIL 2 level (according to IEC 61511) in safety related systems for high risk industries. Output signal can be direct or reverse. Cold junction compensation can be programmed as automatic, using an internal temperature sensor or fixed to a user-customizable temperature value. D6273S offers two independent trip amplifiers via two SPDT output relays.

Mounting on standard DIN-Rail, with or without Power Bus, or on customized Termination Boards.

Fault Detection:

D6273S is able to detect multiple fault sources:

- Sensor Burnout (i.e. when input is disconnected);
- Sensor out of configured range;
- Analog output saturation (beyond user-configured output limits);
- Internal module fault;
- Module out of allowed temperature range (-40 to +70 °C).

The module can be programmed to reflect such fault conditions on Analog Output (Upscale, Downscale, Custom Value) and/or on each Alarm Output.

Technical Data

Supply: 24 Vdc nom (18 to 30 Vdc) reverse polarity protected, ripple within voltage limits ≤ 5 Vpp, 2 A time lag fuse internally protected.

Current consumption @ 24 V: 50 mA with 20 mA output and relays energized typical.

Power dissipation: 1.3 W with 24 V supply, 20 mA output and relays energized typical.

Isolation (Test Voltage): In/Outs 2.5KV; In/Supply 2.5KV; AnalogOut/Supply 500V; Analog Out/Alarm Outs 1.5 KV; Alarm Outs/Supply 1.5 KV; Alarm Out/Alarm Out 1.5KV.

Input: (for details see Input specifications table on page 8) millivolt or thermocouple type A1, A2, A3, B, E, J, K, L, LR, N, R, S, T, U, or 2-3-4 wire RTD Pt50, Pt100, Pt200, Pt300, Pt400, Pt500, Pt1000 to IEC, Pt100 to ANSI, Ni100, Ni120 to DIN43760, Pt46, Pt50, Pt100, Pt200, Pt300, Pt400, Pt500, Cu50, Cu53, Cu100 to GOST6651 (russian standard) and Cu9.035 (or Cu10), or 3 wire transmitting potentiometer (100 Ω to 10 k Ω). Choice between °C/°F. Possibility of configuring user customized sensor (TC or RTD).

Integration time: from 50 ms to 500 ms depending on sensor and fast/slow integration.

Resolution: 1 μ V on mV/TC, 1 m Ω on RTD/resistance, 0.0001 % on potentiometer.

Visualization: 0.1 °C on temp., 10 μ V on mV, 100 m Ω on resistance, 0.1 % on pot.

Input range: within sensor limits (-50 to +80 mV for TC/mV, 0-4 k Ω for resistance).

Measuring RTD current: ≤ 0.15 mA.

2 wire RTD line resistance compensation: ≤ 100 Ω (programmable).

Thermocouple Reference Junction Compensation: programmable as automatic with internal compensator or fixed (-60 to +100 °C).

Thermocouple burnout current: ≤ 50 μ A.

Fault: enabled/disabled. Analog output can be programmed to reflect fault conditions via downscale, highscale or customized value forcing. Fault conditions are also signaled via BUS and by red LED on front panel for each channel. Fault conditions are: Sensor burnout, Sensor out of range, Output saturation, Internal fault, Module out of temperature range.

Output: Fully customizable 0/4 to 20 mA, on max. 300 Ω load source mode, current limited at 24 mA. In sink mode, external voltage generator range is V min. 3.5V at 0 Ω load and V max. 30V. If generator voltage $V_g > 10$ V, a series resistance $\geq (V_g - 10)/0.024$ Ω is needed. The maximum value of series resistance is $(V_g - 3.5)/0.024$ Ω .

Resolution: 1 μ A current output.

Transfer characteristic: linear, direct or reverse on all input sensors.

Response time: ≤ 20 ms (10 to 90 % step).

Output ripple: ≤ 20 mVrms on 250 Ω load.

Modbus Output: Modbus RTU protocol up to 115.200 baud on Bus connector.

Alarm Trip point range: within rated limits of input sensor (see input step resolution).

ON-OFF delay time: 0 to 1000 s, 100 ms step.

Hysteresis: 0-500 °C, 0-50 mV, 0-50 %.

Output: Two voltage free SPDT relay contacts.

Contact material: Ag Alloy (Cd free).

Contact rating: 4 A 250 Vac 1000 VA, 4 A 250 Vdc 120 W (resistive load).

Mechanical / Electrical life: $5 \cdot 10^5 / 3 \cdot 10^4$ operation, typical.

Bounce time NO / NC contact: 3 / 8 ms, typical.

Frequency response: 10 Hz maximum.

Performance: Ref. Conditions 24 V supply, 250 Ω load, 23 ± 1 °C ambient temperature, slow integration speed, 4-wires configuration for RTD.

Input: Calibration and linearity accuracy: see section "Input Specifications".

Temperature influence: $\leq \pm 2$ μ V on mV or thermocouple, ± 20 m Ω on RTD (≤ 300 Ω @ 0°C) or ± 200 m Ω on RTD (> 300 Ω @ 0°C), ± 0.02 % on potentiometer for a 1 °C change.

Ref. Junction Compensation influence: $\leq \pm 1$ °C (thermocouple sensor).

Analog Output: Calibration accuracy: $\leq \pm 0.05$ % of full scale.

Linearity error: $\leq \pm 0.05$ % of full scale.

Supply voltage influence: $\leq \pm 0.02$ % of full scale for a min to max supply change.

Load influence: $\leq \pm 0.02$ % of full scale for a 0 to 100 % load resistance change.

Temperature influence: $\leq \pm 0.01$ % on zero and span for a 1 °C change.

Compatibility:

 CE mark compliant, conforms to Directive: 2014/30/EU EMC, 2014/35/EU LVD, 2011/65/EU RoHS.

Environmental conditions:

Operating: temperature limits -40 to +70 °C, relative humidity 95 %, up to 55 °C.

Storage: temperature limits -45 to +80 °C.

Approvals:



TUV Certificate No. C-IS-722134640-02, SIL 2 according to IEC 61511.

Mounting: EN/IEC60715 TH 35 DIN-Rail, with or without Power Bus.

Weight: 120 g.

Connection: by polarized plug-in disconnect screw terminal blocks to accommodate terminations up to 2.5 mm².

Protection class: IP 20.

Dimensions: Width 12.5 mm, Depth 123 mm, Height 120 mm.

DC Load breaking capacity:

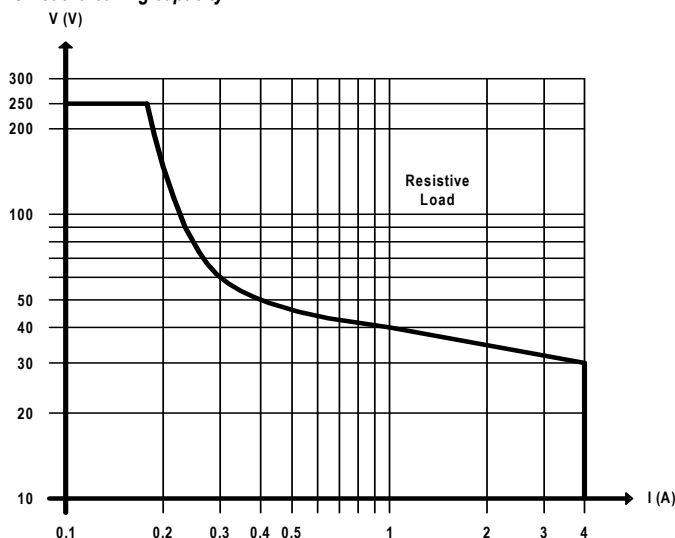

Programming

The module is fully programmable. Operating parameters can be changed from PC via PPC5092 adapter connected to USB serial line and SWC5090 software. Measured values and diagnostic alarms can be read on both serial configuration or Modbus output line. SWC5090 software also allows the Monitoring and Recording of values. For details please see WC5090 manual ISM0154.

Ordering Information

Model:	D6273	
1 channel		S

Power Bus and DIN-Rail accessories:
 Connector JDFT050 Cover and fix MCHP196
 Terminal block male MOR017 Terminal block female MOR022

Front Panel and Features

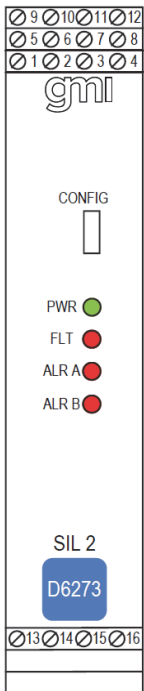

- D6273S SIL 2 according to IEC 61511 for Tproof = 3/10 years ($\leq 10\%$ / $> 10\%$ of total SIF), PFDavg (1 year) 3.15 E-04, SFF 77.08% with analog current output.
- D6273S SIL 2 according to IEC 61511 for Tproof = 2/10 years ($\leq 10\%$ / $> 10\%$ of total SIF), PFDavg (1 year) 3.76 E-04, SFF 74.95% with single alarm trip amplifier and relay output.
- mV, thermocouple, 2 or 3 or 4 wire RTD or transmitting potentiometer Input Signal.
- 2-wire RTD line resistance compensation.
- Internal Reference Junction Compensation automatic or fixed (programmable value).
- Fastest integration time: 50 ms
- 4-20 mA Output Signal temperature linear or reverse.
- Two independent Trip Amplifiers each with SPDT relay contacts 4A 250 Vac 1000VA
- Multiple Fault detection.
- High Accuracy, μP controlled A/D converter.
- Three port isolation, Input/Output/Supply.
- EMC Compatibility to EN61000-6-2, EN61000-6-4, EN61326-1, EN61326-3-1 for safety system.
- Fully programmable operating parameters.
- TÜV Certification.
- High Density, one Analog Output + two Alarms.
- Simplified installation using standard DIN-Rail and plug-in terminal blocks, with or without Power Bus.

Terminal block connections

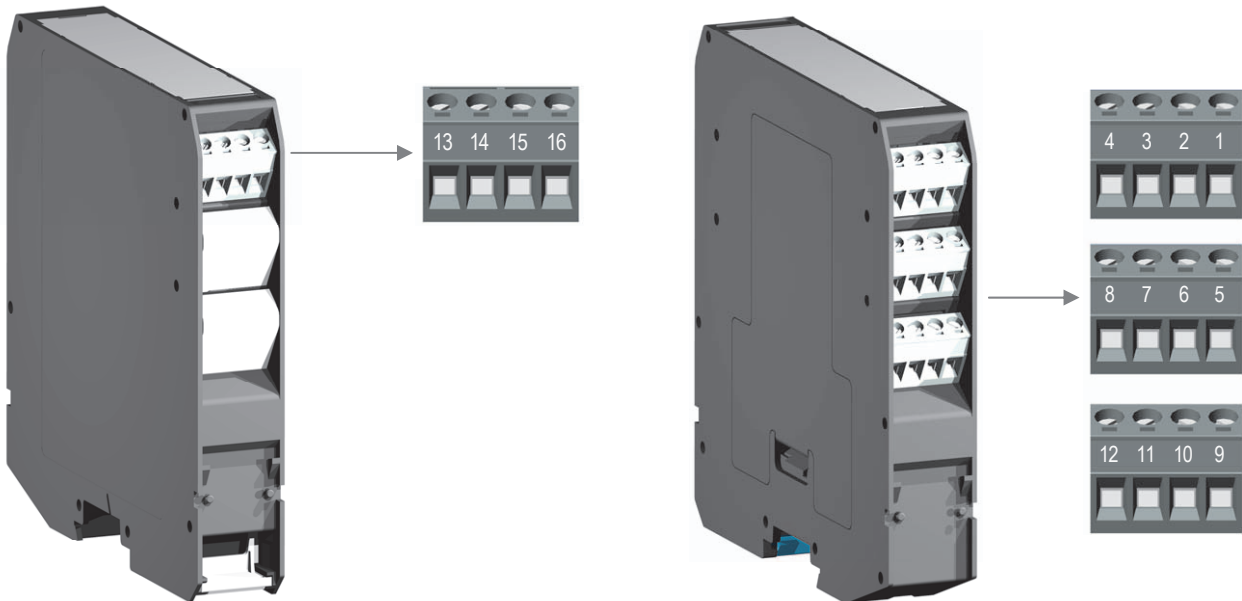

- 13** + Input for thermocouple TC or for 3, 4 wire RTD or potentiometer
- 14** - Input for thermocouple TC or for 2, 3, 4 wire RTD or potentiometer
- 15** Input for 2, 3, 4 wire RTD or potentiometer
- 16** Input for 4 wire RTD

- 1** Common pole (CM1) of Alarm 1 output
- 2** Normally Open pole (NO1) of Alarm 1 output
- 3** Normally Closed pole (NC1) of Alarm 1 output
- 5** Common pole (CM2) of Alarm 2 output
- 6** Normally Open pole (NO2) of Alarm 2 output
- 7** Normally Closed pole (NC2) of Alarm 2 output
- 9** + Power Supply 24 Vdc
- 10** - Power Supply 24 Vdc
- 11** + Analog Output (source current mode) or - Analog Output (sink current mode)
- 12** - Analog Output (source current mode) or + Analog Output (sink current mode)

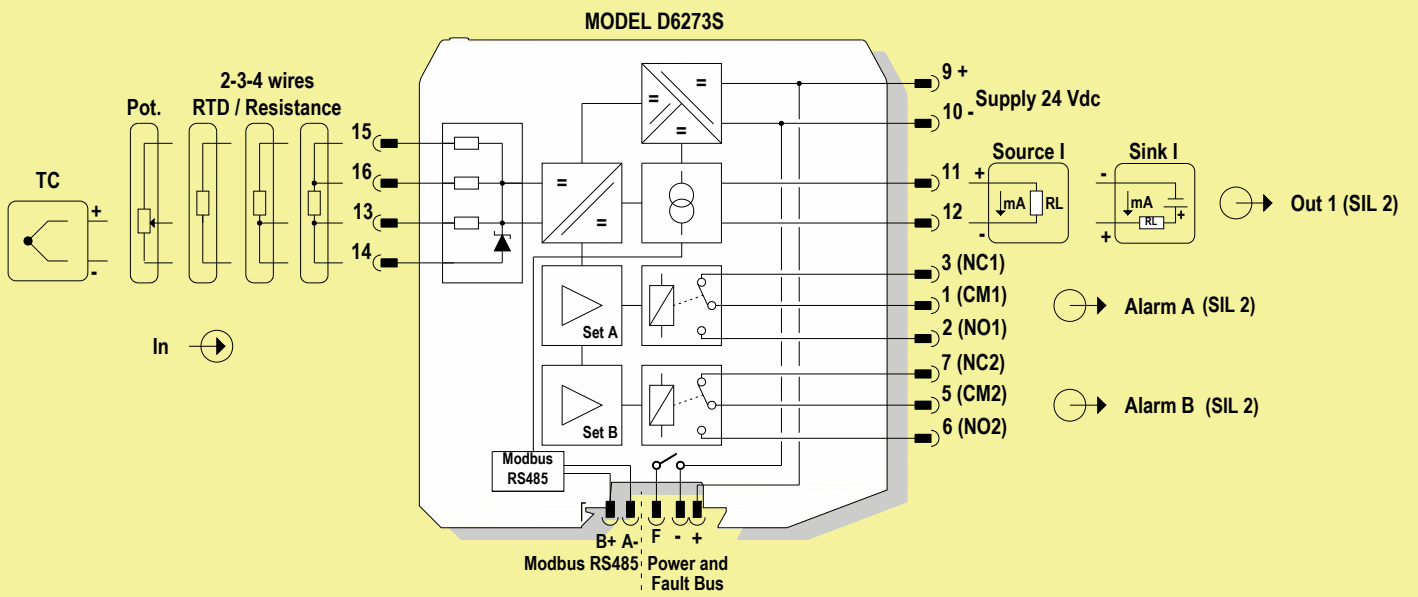

Warning

D6273 series must be installed, operated and maintained only by qualified personnel, in accordance to the relevant national/international installation standards.

Warning: de-energize main power source (turn off power supply voltage) and disconnect plug-in terminal blocks before opening the enclosure to avoid electrical shock when connected to live hazardous potential.

Failure to properly installation or use of the equipment may risk to damage the unit or severe personal injury. The unit cannot be repaired by the end user and must be returned to the manufacturer or his authorized representative. Any unauthorized modification must be avoided.

Operation

The input channel of Temperature Signal Converter, Trip amplifiers D6273 accepts a low level dc signal from millivolt, thermocouple or 2-3-4 wire RTD temperature or transmitting Potentiometer sensor and converts, with isolation, the signal to a 4-20 mA floating output current to drive a load.

Presence of supply power is displayed by a "POWER ON" green signaling LED; integrity of field sensor and connecting line can be monitored by a configurable burnout circuit which, if enabled, can drive analog output signal to upscale or downscale limit. Burnout condition is signaled by red front panel fault LED.

Installation

D6273 series are temperature signal converters housed in a plastic enclosure suitable for installation on EN/IEC60715 TH 35 DIN-Rail, with or without Power Bus or on customized Termination Board. D6273 unit can be mounted with any orientation over the entire ambient temperature range.

Electrical connection of conductors up to 2.5 mm² are accommodated by polarized plug-in removable screw terminal blocks which can be plugged in/out into a powered unit without suffering or causing any damage. Connect only one individual conductor per each clamping point, use conductors up to 2.5 mm² and a torque value of 0.5-0.6 Nm. Use only cables that are suitable for a temperature of at least 85°C.

The wiring cables have to be proportionate in base to the current and the length of the cable.

On the section "Function Diagram" and enclosure side a block diagram identifies all connections.

Identify the function and location of each connection terminal using the wiring diagram on the corresponding section,

as an example (thermocouple input, source current output, both trip amplifier outputs of alarms):

Connect 24 Vdc power supply positive at terminal "9" and negative at terminal "10".

Connect positive output of analog channel at terminal "11" and negative output at "12".

Connect trip amplifier output of alarm 1 at terminal "1" - "2" (for Normally Open NO contact) or "1" - "3" (for Normally Closed NC contact).

Connect trip amplifier output of alarm 2 at terminal "5" - "6" (for Normally Open NO contact) or "5" - "7" (for Normally Closed NC contact).

Connect thermocouple positive extension wire at terminal "13", negative and shield (if any) at terminal "14".

Make sure that compensating wires have the correct metal and thermal e.m.f. and are connected to the appropriate thermocouple terminal, note that a wrong compensating cable type or a swapped connection is not immediately apparent but introduces a misleading measurement error that appears as a temperature drift.

Connect SPST alarm contacts checking the load rating to be within the contact maximum rating 4 A 250 Vac 1000 VA, 4 A 250 Vdc 120 W (resistive load).

To prevent alarm relay contacts from damaging, connect an external protection (fuse or similar), chosen according to the relay breaking capacity diagram on data sheet.

The enclosure provides, according to EN60529, an IP20 minimum degree of protection (or similar to NEMA Standard 250 type 1). The unit shall be installed in an area of not more than pollution degree 2 according to EN/IEC60664-1.

Units must be protected against dirt, dust, extreme mechanical (e.g. vibration, impact and shock) and thermal stress, and casual contacts.

If enclosure needs to be cleaned use only a cloth lightly moistened by a mixture of detergent in water.

Any penetration of cleaning liquid must be avoided to prevent damage to the unit. Any unauthorized modification must be avoided.

According to EN61010, D6273 series must be connected to SELV or SELV-E supplies.

All circuits connected to D6273 unit must comply with the overvoltage category II (or better) according to EN/IEC60664-1.

Alarm relay output contacts must be connected to load non exceeding category II overvoltage limits.

Warning: de-energize main power source (turn off power supply voltage) and disconnect plug-in terminal blocks before opening the enclosure to avoid electrical shock when connected to live hazardous potential.

Start-up

Before powering the unit check that all wires are properly connected, particularly supply conductors and their polarity, input and output wires.

Check conductors for exposed wires that could touch each other causing dangerous unwanted shorts.

Turn on power, the "power on" green LED must be lit, output signal must be in accordance with the corresponding input signal value and input/output chosen transfer function, alarm LED should reflect the input variable condition with respect to trip points setting. If possible change the sensor condition and check the corresponding output.

Input specifications:

Input	Type	Alpha	Ohms	Standards	Min Span	Accuracy	Accuracy Range	Maximum Range
RTD	Platinum	0.003850	50	IEC 60751	30 °C (54 °F)	±0.4 °C ±0.7 °F	-200 to 850 °C (-328 to 1562 °F)	-200 to 850 °C (-328 to 1562 °F)
			100	IEC 60751	20 °C (36 °F)	±0.2 °C ±0.4 °F	-200 to 850 °C (-328 to 1562 °F)	-200 to 850 °C (-328 to 1562 °F)
			200	IEC 60751		±0.2 °C ±0.4 °F	-200 to 850 °C (-328 to 1562 °F)	-200 to 850 °C (-328 to 1562 °F)
			300	IEC 60751		±0.2 °C ±0.4 °F	-200 to 850 °C (-328 to 1562 °F)	-200 to 850 °C (-328 to 1562 °F)
			400	IEC 60751		±0.2 °C ±0.4 °F	-200 to 850 °C (-328 to 1562 °F)	-200 to 850 °C (-328 to 1562 °F)
			500	IEC 60751		±0.2 °C ±0.4 °F	-200 to 850 °C (-328 to 1562 °F)	-200 to 850 °C (-328 to 1562 °F)
			1000	IEC 60751		±0.2 °C ±0.4 °F	-200 to 850 °C (-328 to 1562 °F)	-200 to 850 °C (-328 to 1562 °F)
		0.003916	100	ANSI		20 °C (36 °F)	±0.2 °C ±0.4 °F	-200 to 625 °C (-328 to 1157 °F)
		0.003910	46	GOST 6651	20 °C (36 °F)	±0.4 °C ±0.7 °F	-200 to 650 °C (-328 to 1202 °F)	-200 to 650 °C (-328 to 1202 °F)
			50	GOST 6651		±0.4 °C ±0.7 °F	-200 to 650 °C (-328 to 1202 °F)	-200 to 650 °C (-328 to 1202 °F)
			100	GOST 6651		±0.2 °C ±0.4 °F	-200 to 650 °C (-328 to 1202 °F)	-200 to 650 °C (-328 to 1202 °F)
			200	GOST 6651		±0.2 °C ±0.4 °F	-200 to 650 °C (-328 to 1202 °F)	-200 to 650 °C (-328 to 1202 °F)
			300	GOST 6651		±0.2 °C ±0.4 °F	-200 to 650 °C (-328 to 1202 °F)	-200 to 650 °C (-328 to 1202 °F)
			400	GOST 6651		±0.2 °C ±0.4 °F	-200 to 650 °C (-328 to 1202 °F)	-200 to 650 °C (-328 to 1202 °F)
	Nickel	0.00618	100	DIN 43760	20 °C (36 °F)	±0.2 °C ±0.4 °F	-60 to 180 °C (-76 to 356 °F)	-60 to 180 °C (-76 to 356 °F)
		0.00672	120	DIN 43760		±0.2 °C ±0.4 °F	-80 to 320 °C (-112 to 608 °F)	-80 to 320 °C (-112 to 608 °F)
	Copper	0.00428	50	GOST 6651	30 °C (54 °F)	±0.4 °C ±0.7 °F	-50 to 200 °C (-58 to 392 °F)	-50 to 200 °C (-58 to 392 °F)
			53	GOST 6651	30 °C (54 °F)	±0.4 °C ±0.7 °F	-50 to 200 °C (-58 to 392 °F)	-50 to 200 °C (-58 to 392 °F)
			100	GOST 6651	20 °C (36 °F)	±0.2 °C ±0.4 °F	-50 to 200 °C (-58 to 392 °F)	-50 to 200 °C (-58 to 392 °F)
		0.00427	9.035	---	40 °C (72 °F)	±1.0 °C ±1.8 °F	-50 to 260 °C (-58 to 500 °F)	-50 to 260 °C (-58 to 500 °F)
	Ohm	Resistance	0 to 4000	---	---	10 ohm	±0.4 ohm	0 to 4000
Potentiometer		100 to 10000	---	---	10%	±0.1%	0 to 100%	0 to 100%
TC	A1	---	GOST 8.585-2001	100 °C (180 °F)	±0.75 °C ±1.35 °F	25 to 2500 °C (77 to 4532 °F)	-10 to 2500 °C (14 to 4532 °F)	
	A2	---	GOST 8.585-2001	100 °C (180 °F)	±0.75 °C ±1.35 °F	25 to 1800 °C (77 to 3272 °F)	-10 to 1800 °C (14 to 3272 °F)	
	A3	---	GOST 8.585-2001	100 °C (180 °F)	±0.75 °C ±1.35 °F	25 to 1800 °C (77 to 3272 °F)	-10 to 1800 °C (14 to 3272 °F)	
	B	---	IEC 60584 GOST 8.585-2001	75 °C (135 °F)	±0.75 °C ±1.35 °F	180 to 1800 °C (356 to 3272 °F)	-10 to 1800 °C (14 to 3272 °F)	
	E	---	IEC 60584 GOST 8.585-2001	40 °C (72 °F)	±0.3 °C ±0.6 °F	-100 to 1000 °C (-148 to 1832 °F)	-250 to 1000 °C (-418 to 1832 °F)	
	J	---	IEC 60584 GOST 8.585-2001	40 °C (72 °F)	±0.3 °C ±0.6 °F	-125 to 750 °C (-193 to 1382 °F)	-200 to 1200 °C (-328 to 2192 °F)	
	K	---	IEC 60584 GOST 8.585-2001	40 °C (72 °F)	±0.3 °C ±0.6 °F	-125 to 1350 °C (-193 to 2462 °F)	-250 to 1350 °C (-418 to 2462 °F)	
	L	---	DIN 43710	40 °C (72 °F)	±0.3 °C ±0.6 °F	-100 to 800 °C (-148 to 1472 °F)	-200 to 800 °C (-328 to 1472 °F)	
	LR	---	GOST 8.585-2001	40 °C (72 °F)	±0.3 °C ±0.6 °F	-75 to 800 °C (-103 to 1472 °F)	-200 to 800 °C (-328 to 1472 °F)	
	N	---	IEC 60584 GOST 8.585-2001	40 °C (72 °F)	±0.3 °C ±0.6 °F	-100 to 1300 °C (-148 to 2372 °F)	-250 to 1300 °C (-418 to 2372 °F)	
	R	---	IEC 60584 GOST 8.585-2001	50 °C (90 °F)	±0.5 °C ±0.9 °F	75 to 1750 °C (167 to 3182 °F)	-50 to 1750 °C (-58 to 3182 °F)	
	S	---	IEC 60584 GOST 8.585-2001	50 °C (90 °F)	±0.5 °C ±0.9 °F	75 to 1750 °C (167 to 3182 °F)	-50 to 1750 °C (-58 to 3182 °F)	
	T	---	IEC 60584 GOST 8.585-2001	40 °C (72 °F)	±0.3 °C ±0.6 °F	-100 to 400 °C (-148 to 752 °F)	-250 to 400 °C (-418 to 752 °F)	
	U	---	DIN 43710	40 °C (72 °F)	±0.3 °C ±0.6 °F	-100 to 400 °C (-148 to 752 °F)	-200 to 600 °C (-328 to 1112 °F)	
mV	DC	---	---	---	10 mV	±10 µV	-50 to 80 mV	-50 to 80 mV

Notes:

RTD/resistance accuracy shown in 4-wires configuration, in slow integration speed

TC/mV Accuracy shown in slow integration speed

Configuration parameters:

INPUT:

Sensor Connection:

- TC
- RTD
- Potentiometer
- Voltage
- Resistance

Sensor Type: input sensor type (see list in section "Input specifications")

possibility of configuring a completely customized TC/RTD input curve

Wires: 2, 3, 4 wires selection for RTD/Resistance inputs

Lowscale: input value of measuring range corresponding to defined low output value.

Upscale: input value of measuring range corresponding to defined high output value.

Cold Junction Source: reference junction compensation type (thermocouple only)

- Automatic via internal compensator (1 for each channel)
- Fixed programmable temperature compensation at fixed temperature

Cold Junction Reference: fixed temperature compensation value (Cold Junction type Fixed only), range from -60 to +100 °C.

Integration speed:

- Slow 250 ms (mV/TC, 2 wire RTD); 375 ms (Pot.), 500 ms (3, 4 wire RTD)
- Fast 50 ms (mV/TC, 2 wire RTD); 75 ms (Pot.), 100 ms (3, 4 wire RTD)

Mains Frequency:

- 50 Hz
- 60 Hz only available with fast integration speed

Offset: value to be added/subtracted to input (µV or mΩ depending on input sensor);

Multiplier: input multiplication value;

Tag: 16 alphanumeric characters

OUTPUT:

Function:

- Input 1 analog output represents input of first channel,

Type:

- 4-20 mA Sink (for SIL applications)
- 0-20 mA Sink
- Custom Sink fully customizable range from 0 to 24 mA, Sink mode
- 4-20 mA Source (for SIL applications)
- 0-20 mA Source
- Custom Source fully customizable range from 0 to 24 mA, Source mode

Downscale: output downscale in normal condition (range 0 to 24 mA)

Upscale: output upscale in normal condition (range 0 to 24 mA)

Under Range: analog output downscale in Under Range condition (range 0 to 24 mA)

Over Range: analog output upscale in Over Range condition (range 0 to 24 mA)

Fault Output Value: analog output value in case of fault condition (range 0 to 24 mA)

Fault in case of: analog output is forced to "Fault Output Value" in case of:

- Burnout input sensor interruption,
- Internal fault module internal fault,
- Sensor out of range input sensor out of configured input range,
- Output Saturation output is below Under Range or above Over Range,
- Module Temp. Out of range internal module temperature under or over specified module operating temperature limits.

ALARM:

Type:

- None alarm is disabled,
- Low alarm is triggered when source descends below "Low Set",
- LowLock alarm is inhibited until source ascends over "Low Set", and then, it behaves as a standard "Low" configuration,
- High alarm is triggered when source ascends over "High Set",
- HighLock alarm is inhibited until source descends below "High Set", and then, it behaves as a standard "High" configuration,
- Window alarm is triggered below "Low Set" and above "High Set",
- Fault Repeater alarm output reflects selected (one or more) Fault status.

Source: reference value for alarm triggering

- Input 1 input of first channel,

Condition:

- NE alarm output is normally energized when deactivated, for SIL applications
- ND alarm output is normally de-energized when deactivated.

Low Set: source value at which the alarm is triggered (in Low, LowLock, Window)

Low Hysteresis: triggered Low alarm deactivates when source value reaches Low Set + Low Hysteresis (0-500 °C, 0-50 mV, 0-50 %, 0 to 2 KΩ)

High Set: source value at which the alarm is triggered (in High, HighLock, Window)

High Hysteresis: triggered High alarm deactivates when source value reaches High Set - High Hysteresis (0-500 °C, 0-50 mV, 0-50 %, 0 to 2 KΩ)

On Delay: time for which the source variable has to be in alarm condition before the alarm output is triggered; configurable from 0 to 1000 seconds in steps of 100 ms

Off Delay: time for which the source variable has to be in normal condition before the alarm output is deactivated; configurable from 0 to 1000 seconds in steps of 100 ms

In case of fault:

- Ignore alarm is not affected
- Lock status alarm remains in the same status as it was before Fault occurred
- Go On alarm is triggered,
- Go Off alarm is deactivated

Faults: if "Type" is set to "Fault repeater" select which faults will be repeated by alarm output; if "In case of fault" is different from "Ignore", select which faults should influence alarm output behaviour.

Note: Each alarm has completely independent configurations
See ISM0154 Manual for details on SWC5090 software.

Screenshots:

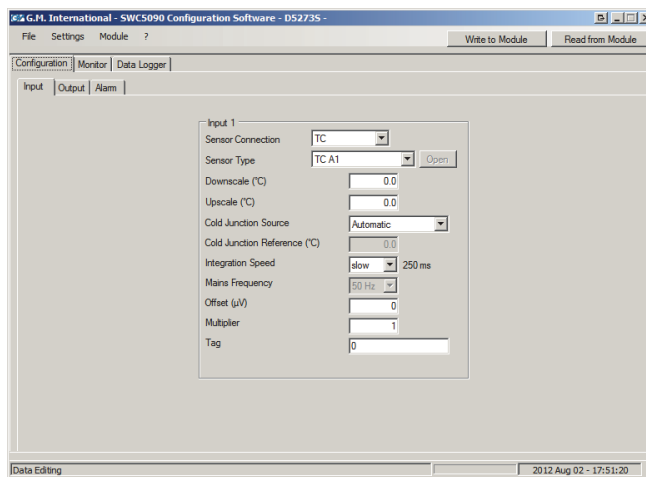

Input configuration

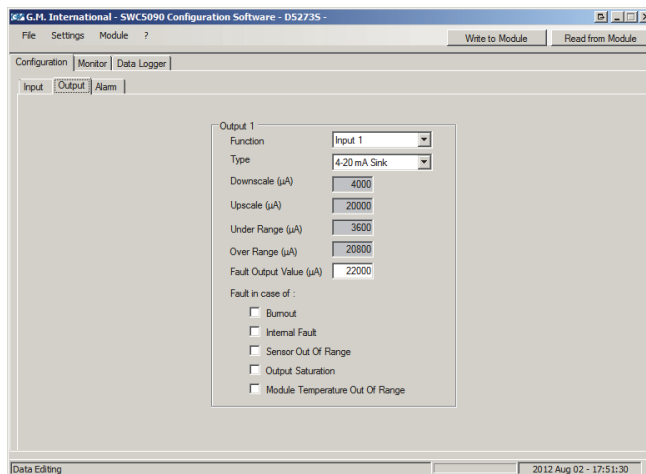

Output configuration

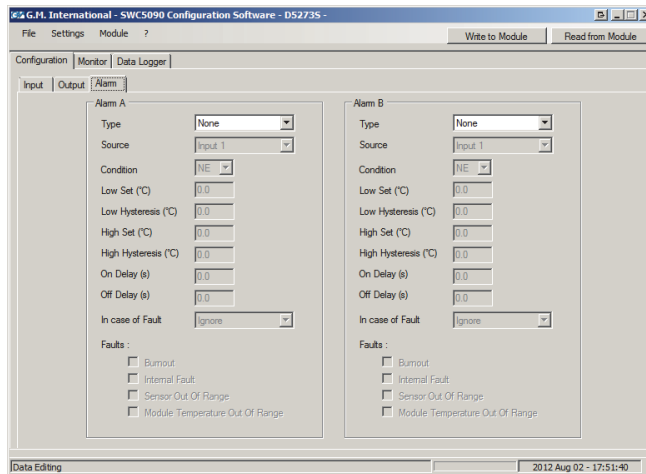

Alarm configuration

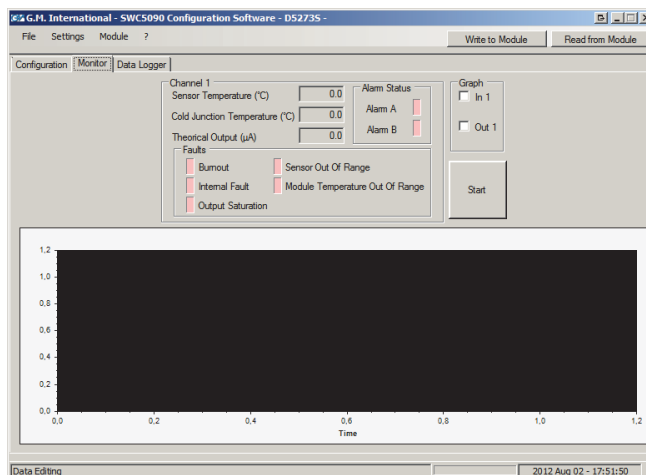

Monitor

Supported Modbus parameters:

The unit can communicate via Modbus RTU RS-485 protocol. Below is a list of all registers.

Addr.	Description	Notes	Type ⁽¹⁰⁾		
0	G.M. Factory Code	Identification Data	R		
1	Instrument Code				
2	Option Code				
3	Hardware Release				
4	Software Release				
16	Modbus Address	Communication Data	R/W		
17	Modbus Baudrate ⁽¹⁾				
18	Modbus Format ⁽¹⁾				
71	Ch. 1 Measured Value (Low 16 bits) ⁽⁵⁾	Input Data	R		
72	Ch. 1 Measured Value (High 16 bits) ⁽⁵⁾				
73	Ch. 1 Cold Junction value ⁽²⁾				
74	Ch. 1 Input temperature ⁽³⁾⁽⁸⁾				
75	Ch. 1 Fault status ⁽¹⁾				
116	Ch. 1 Input Configuration ⁽¹⁾			Input Configuration	R/W
117	Ch. 1 Sensor Type ⁽¹⁾				
118	Ch. 1 Fixed Cold junction temp. value ⁽⁸⁾				
119	Ch. 1 Offset (Low 16 bits) ⁽⁵⁾				
120	Ch. 1 Offset (High 16 bits) ⁽⁵⁾				
121	Ch. 1 Multiplier				
122	Ch. 1 Divider				
123	Ch. 1 Downscale (Low 16 bits) ⁽⁶⁾				
124	Ch. 1 Downscale (High 16 bits) ⁽⁶⁾				
125	Ch. 1 Highscale (Low 16 bits) ⁽⁶⁾				
126	Ch. 1 Highscale (High 16 bits) ⁽⁶⁾				
138	Cold Junction source selection ⁽¹⁾				
160	Ch. 1 Output configuration ⁽¹⁾	Output Configuration	R/W		
161	Ch. 1 Downscale ⁽⁷⁾				
162	Ch. 1 Under Range ⁽⁷⁾				
163	Ch. 1 Upscale ⁽⁷⁾				
164	Ch. 1 Over Range ⁽⁷⁾				
166	Ch. 1 Fault current ⁽⁷⁾				
240	Alarm A Configuration ⁽¹⁾	Alarm Control	R/W		
241	Alarm A Fault Configuration ⁽¹⁾				
242	Alarm A Source ⁽¹⁾				
243	Alarm A Low Threshold (Low 16 bits) ⁽⁶⁾				
244	Alarm A Low Threshold (High 16 bits) ⁽⁶⁾				
245	Alarm A Low Hysteresis (Low 16 bits) ⁽⁶⁾				
246	Alarm A Low Hysteresis (High 16 bits) ⁽⁶⁾				
247	Alarm A High Threshold (Low 16 bits) ⁽⁶⁾				
248	Alarm A High Threshold (High 16 bits) ⁽⁶⁾				
249	Alarm A High Hysteresis (Low 16 bits) ⁽⁶⁾				
250	Alarm A High Hysteresis (High 16 bits) ⁽⁶⁾				
251	Alarm A Delay ON ⁽⁹⁾				
252	Alarm A Delay OFF ⁽⁹⁾				
253	Alarm B Configuration ⁽¹⁾				
254	Alarm B Fault Configuration ⁽¹⁾				
255	Alarm B Source ⁽¹⁾				
256	Alarm B Low Threshold (Low 16 bits) ⁽⁶⁾				
257	Alarm B Low Threshold (High 16 bits) ⁽⁶⁾				
258	Alarm B Low Hysteresis (Low 16 bits) ⁽⁶⁾				
259	Alarm B Low Hysteresis (High 16 bits) ⁽⁶⁾				
260	Alarm B High Threshold (Low 16 bits) ⁽⁶⁾				
261	Alarm B High Threshold (High 16 bits) ⁽⁶⁾				
262	Alarm B High Hysteresis (Low 16 bits) ⁽⁶⁾				
263	Alarm B High Hysteresis (High 16 bits) ⁽⁶⁾				
264	Alarm B Delay ON ⁽⁹⁾				
265	Alarm B Delay OFF ⁽⁹⁾				
464	Command execution ⁽⁴⁾	Command	W		
524	Ch. 1 Output Current Saturation Fault	Output data	R		
525	Ch. 1 Theoretical Output Current ⁽⁷⁾				
532	Alarm A Status	Alarm data	R		
533	Alarm B Status				
556	Ch. 1 chars 0,1	Tags	R/W		
557	Ch. 1 chars 2,3				
558	Ch. 1 chars 4,5				
559	Ch. 1 chars 6,7				
560	Ch. 1 chars 8,9				
561	Ch. 1 chars 10,11				
562	Ch. 1 chars 12,13				
563	Ch. 1 chars 14,15				

Supported modbus functions:

Code	Name	Notes
03	read holding registers	reads a stream of words from memory
04	read input registers	reads a stream of words from memory
08	diagnostics: subcode 0	returns query data
06	write single register	writes a word in memory
16	write multiple registers	writes a stream of words in memory

Notes:

Each Modbus parameter is described by one 16-bit word.
Commands related to Channel 2 are valid only for model D5072D

- (1) see command details on next page.
- (2) Returned value must be divided by 16 to obtain Temperature in ° Celsius.
- (3) Value is valid only when Input source is Tc or RTD.
- (4) All configurations must be confirmed via Addr. 464, see details on next page.
- (5) Expressed in:
 - μV when Input Connection is Tc or Voltage;
 - mΩ when Input Connection is RTD or Resistance;
 - ppm when Input Connection is Potentiometer.
- (6) Expressed in: μV when Input Connection is Voltage; Tenths of °C when Input Connection is Tc or RTD; mΩ when Input Connection is Resistance; ppm when Input Connection is Potentiometer.
- (7) Expressed in μA.
- (8) Expressed in Tenths of ° Celsius.
- (9) Expressed in Tenths of seconds.
- (10) Parameter Type:
 - R = read only,
 - W = write only,
 - R/W = read and write.

Modbus parameters details:

Address 17: Supported ModBus Baudrates	
Index	Baudrate
0	4800
1	9600
2	19200
3	38400
4	57600
5	115200

Address 18: Supported ModBus Formats															
High Byte	Low Byte														
Bit position															
15	14	13	12	11	10	9	8	7	6	5	4	3	2	1	0

Endianness 32 bit Data (0 = Little; 1 = Big)

Termination resistance (1 = enabled)

Supported Modbus Parity:

0 8 data bit, no parity, 1 stop bit

1 8 data bit, even parity, 1 stop bit

2 8 data bit, odd parity, 1 stop bit

Address 75 and 80: Input Fault status															
High Byte	Low Byte														
Bit position															
15	14	13	12	11	10	9	8	7	6	5	4	3	2	1	0

Module temperature out of range

Internal communication fault

Input sensor out of range

Input sensor Burnout

Internal cold junction sensor fault

Address 116 and 127: Input Configuration															
High Byte	Low Byte														
Bit position															
15	14	13	12	11	10	9	8	7	6	5	4	3	2	1	0

Mains supply freq. (0 = 50 Hz; 1 = 60 Hz)

Integration speed (0 = Slow; 1 = Fast)

Sensor connection:

0 Tc / Voltage (only SW revision 0)

1 RTD / Resistance 2-wires

2 RTD / Resistance 3-Wires

3 RTD / Resistance 4-Wires

4 Potentiometer

5 Tc / Voltage (only SW revision ≥ 1)

Address 117 and 128: Input Sensor Type															
High Byte	Low Byte														
Bit position															
15	14	13	12	11	10	9	8	7	6	5	4	3	2	1	0

Available sensor types:

0 Tc A1	10 Tc R	20 Pt 1000 (385)	30 Ni 120 (672)
1 Tc A2	11 Tc S	21 Pt 100 (393)	31 Cu 53 (426)
2 Tc A3	12 Tc T	22 Pt 46 (391)	32 Cu 50 (428)
3 Tc B	13 Tc U	23 Pt 50 (391)	33 Cu 100 (428)
4 Tc E	14 Pt 50 (385)	24 Pt 100 (391)	34 Cu 9.035 (427)
5 Tc J	15 Pt 100 (385)	25 Pt 200 (391)	35 Voltage
6 Tc K	16 Pt 200 (385)	26 Pt 300 (391)	36 Resistance
7 Tc L	17 Pt 300 (385)	27 Pt 400 (391)	37 Custom device
8 Tc Lr	18 Pt 400 (385)	28 Pt 500 (391)	38 Potentiometer
9 Tc N	19 Pt 500 (385)	29 Ni 100 (618)	

Address 138: Cold Junction Source selection															
High Byte	Low Byte														
Bit position															
15	14	13	12	11	10	9	8	7	6	5	4	3	2	1	0

All bits '0' for Automatic Internal CJC (SW rev.= 0)

Ch. 1 Automatic Internal CJC (SW rev. ≥ 1)

Ch. 1 Fixed Cold Junction

Address 160 and 167: Output Configuration															
High Byte	Low Byte														
Bit position															
15	14	13	12	11	10	9	8	7	6	5	4	3	2	1	0

Internal CJC Fault

Burnout

Output Saturation

Sensor out of range

Internal comm. fault

Out of temp. range

Output Source:
0 Input 1

Out type:

0 Sink

1 Source

Address 242 and 255: Alarm Source															
High Byte	Low Byte														
Bit position															
15	14	13	12	11	10	9	8	7	6	5	4	3	2	1	0

Alarm source:
0 Input 1

Address 240 and 253: Alarm Configuration															
High Byte	Low Byte														
Bit position															
15	14	13	12	11	10	9	8	7	6	5	4	3	2	1	0

Alarm Condition: 0 NE, 1 ND

Alarm Type: 0 None, 1 Low, 2 Low Lock, 3 High, 4 High Lock, 5 Window, 6 Fit repeat

Address 241 and 254: Alarm Fault Configuration															
High Byte	Low Byte														
Bit position															
15	14	13	12	11	10	9	8	7	6	5	4	3	2	1	0

Out of temperature

Internal comm. fault

Sensor out of range

Burnout

Internal CJC fault

Configuration:
0 Ignore
1 Fit Lock
2 To ON
3 To OFF

Address 464: Various commands															
High Byte	Low Byte														
Bit position															
15	14	13	12	11	10	9	8	7	6	5	4	3	2	1	0

- 1 Save Input/Output Configuration
- 2 Save Modbus configuration
- 8 Save Tags
- 9 Lock Alarms
- 10 Analog Output Sink/Source Switch