



# INSTRUCTION MANUAL

SIL 3 Switch/Proximity Detector Repeater  
Relay Output, Termination Board  
Models D6032S, D6032D



## Characteristics

**General Description:** The single and dual channel Switch/Proximity Detector Repeater, D6032S and D6032D module is a unit suitable for applications requiring SIL 3 level (according to IEC 61508:2010 Ed. 2) in safety related systems for high risk industries.

The unit can be configured for switch or proximity detector (EN60947-5-6, NAMUR), NO or NC and for NE or ND SPST relay output contact.

Each channel enables a load to be controlled by a switch, or a proximity detector.

Fault detection circuit (DIP switch configurable) is available for both proximity sensor and switch equipped with end of line resistors.

In case of fault, when enabled it de-energizes the corresponding output relay and turns the fault LED on; when disabled the corresponding output relay repeats the input line open or closed status as configured.

D6032D is programmable via dip switches as single input and two independent outputs. Out 2 can be programmed for output duplicating Out 1 or Fault detection Out.

In case of duplication, relay actuation can be independently configured for each output.

In case of fault output, relay actuation can be programmed as normally energized or normally de-energized.

Mounting on customized Termination Boards.

### Functional Safety Management Certification:

G.M. International is certified by TÜV to conform to IEC61508:2010 part 1 clauses 5-6 for safety related systems up to and included SIL3.



## Technical Data

**Supply:** 24 Vdc nom (18 to 30 Vdc) reverse polarity protected, ripple within voltage limits  $\leq 5$  Vpp, 2 A time lag fuse internally protected.

**Current consumption @ 24 V:** 35 mA for 2 channels D6032D, 18 mA for 1 channel D6032S with short circuit input and relay energized, typical.

**Power dissipation:** 0.85 W for 2 channels D6032D, 0.45 W for 1 channel D6032S with 24 V supply voltage, short circuit input and relay energized, typical.

**Isolation (Test Voltage):** In/Out 2.5 KV; In/Supply 2.5 KV; In/In 500 V; Out/Supply 500 V; Out/Out 500 V.

**Input switching current levels:** ON  $\geq 2.1$  mA (1.9 to 6.2 mA range), OFF  $\leq 1.2$  mA (0.4 to 1.3 mA range), switch current  $\approx 1.65$  mA  $\pm 0.2$  mA hysteresis.

**Fault current levels:** open fault  $\leq 0.2$  mA, short fault  $\geq 6.8$  mA (when enabled both faults de-energize channel relay with single channel unit D6032S or de-energize channel relay with D6032D used as dual channel unit or actuate the fault relay out with D6032D used as fault signaling unit).

**Input equivalent source:** 8 V 1 K $\Omega$  typical (8 V no load, 8 mA short circuit).

**Output:** voltage free SPST relay contact.

**Contact material:** Ag Alloy (Cd free), gold plated.

**Contact rating:** 4 A 250 Vac 1000 VA, 4 A 250 Vdc 120 W (resistive load). Min. switching current 1 mA.

**Mechanical / Electrical life:** 5 \* 10<sup>6</sup> / 1 \* 10<sup>6</sup> operation, typical.

**Operate / Release time:** 8 / 4 ms typical.

**Bounce time NO / NC contact:** 3 / 8 ms typical.

**Frequency response:** 10 Hz maximum.

### Compatibility:



CE mark compliant, conforms to Directive: 2014/30/EU EMC, 2014/35/EU LVD, 2011/65/EU RoHS.

### Environmental conditions:

**Operating:** temperature limits - 40 to + 70 °C, relative humidity 95 %, up to 55 °C.

**Storage:** temperature limits - 45 to + 80 °C.

### Approvals:



TÜV Certificate No. C-IS-722134640-01, SIL 2 / SIL 3 conforms to IEC61508:2010 Ed.2.

TÜV Certificate No. C-IS-236198-09, SIL 3 Functional Safety Certificate conforms to IEC61508:2010 Ed.2, for Management of Functional Safety.

### Mounting:

on customized Termination Board.

**Weight:** about 125 g D6032D, 115 g D6032S.

**Connection:** by polarized plug-in disconnect screw terminal blocks to accommodate terminations up to 2.5 mm<sup>2</sup>.

**Protection class:** IP 20.

**Dimensions:** Width 12.5 mm, Depth 123 mm, Height 120 mm.

## Ordering Information

Model:	D6032	
1 channel		S
2 channels		D

## Front Panel and Features

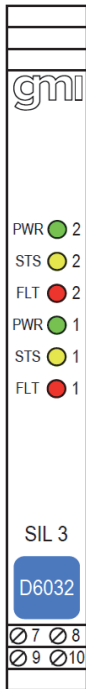

- SIL 3 according to IEC 61508:2010 Ed. 2 for Tproof = 2 / 10 years ( $\leq 10\%$  /  $> 10\%$  of total SIF), considering 100 mA max contact current.
- SIL 2 according to IEC 61508:2010 Ed. 2 for Tproof = 20 years ( $\leq 10\%$  of total SIF), considering 100 mA max contact current.
- PFDavg (1 year) 4.92 E-05, SFF 90.06 %, with independent channel configuration.  
PFDavg (1 year) 4.96 E-05, SFF 93.16 %, with D6032D used as duplicator (both channels) or as fault indicator (only 1st ch.).  
PFDavg (1 year) 4.66 E-05, SFF 93.53 %, with D6032D used as fault indicator (only 2nd ch.).
- Systematic capability SIL 3
- 2 fully independent channels.
- NO/NC switch/proximity Detector Input, NE/ND relay actuation mode.
- Field open and short circuit detection.
- Three port isolation, Input/Output/Supply.
- EMC Compatibility to EN61000-6-2, EN61000-6-4, EN61326-1, EN61326-3-1 for safety system.
- In-field programmability by DIP Switch.
- TÜV Certification.
- TÜV Functional Safety Certification.
- High Density, two channels per unit.
- Simplified installation using customized Termination Boards.

## Terminal block connections

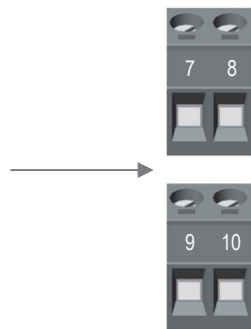

- 7** + Input Ch 1 for Proximity or Voltage free Contact
- 8** - Input Ch 1 for Proximity or Voltage free Contact
- 9** + Input Ch 2 for Proximity or Voltage free Contact
- 10** - Input Ch 2 for Proximity or Voltage free Contact

MODEL D6032D

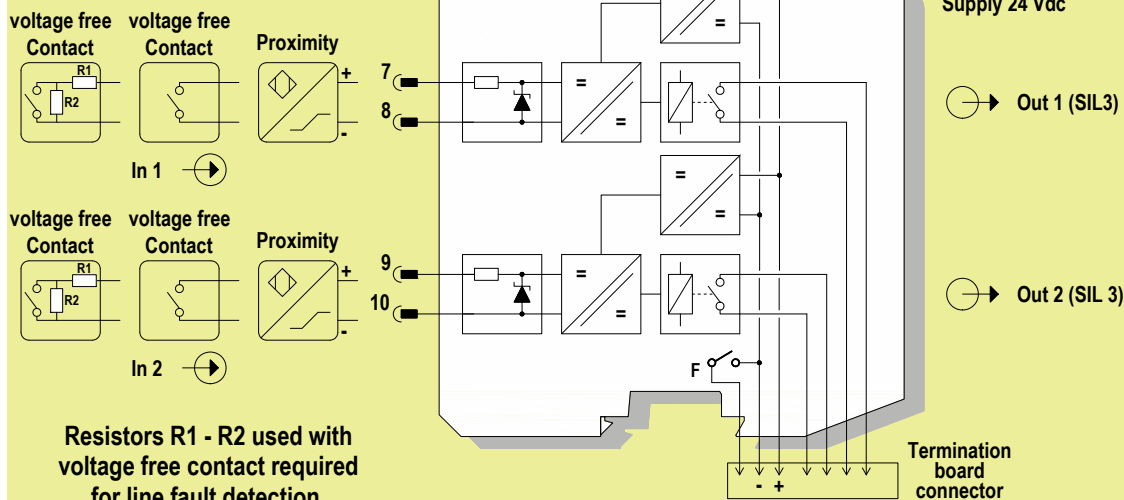

Resistors R1 - R2 used with voltage free contact required for line fault detection.

Terminals 9-10 must be shorted to set module as Duplicator or Fault Out

Relay contacts shown in de-energized position

MODEL D6032D Duplicator or Fault Out

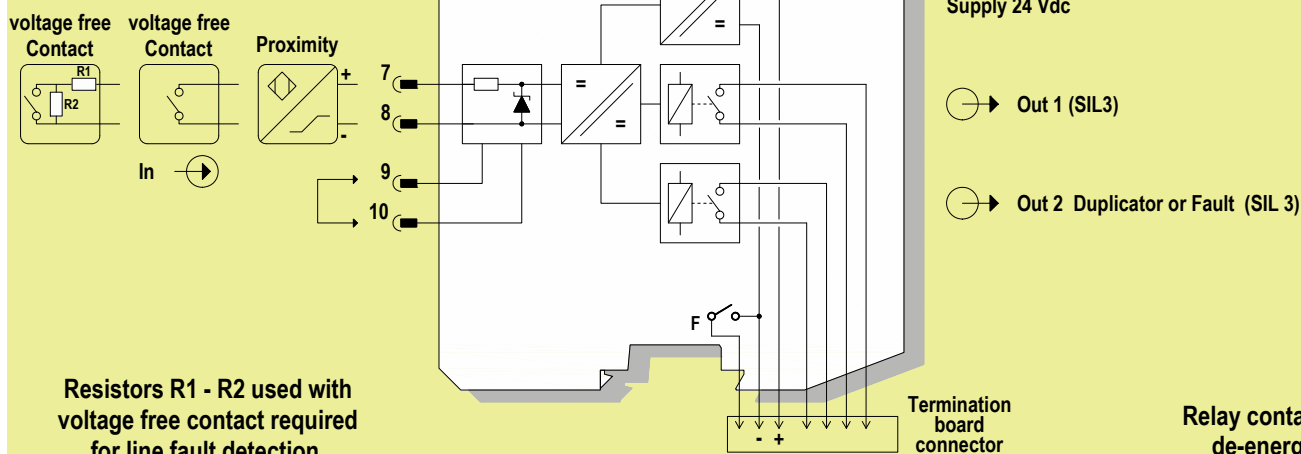

Resistors R1 - R2 used with voltage free contact required for line fault detection.

Internal Dip switches programmable

Relay contacts shown in de-energized position

MODEL D6032S

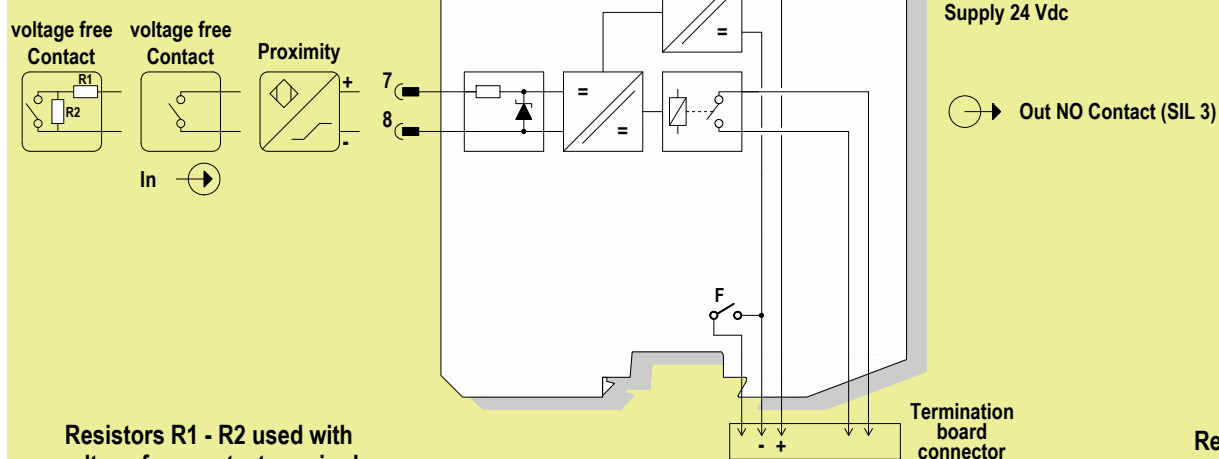

Resistors R1 - R2 used with voltage free contact required for line fault detection.

Relay contact shown in de-energized position

## Warning

D6032 series must be installed, operated and maintained only by qualified personnel, in accordance to the relevant national/international installation standards. Failure to properly installation or use of the equipment may risk to damage the unit or severe personal injury. The unit cannot be repaired by the end user and must be returned to the manufacturer or his authorized representative. Any unauthorized modification must be avoided.

## Operation

D6032 module is a unit suitable for applications requiring SIL 3 level (according to IEC 61508) in safety related systems for high risk industries. The unit can be configured for switch or proximity detector (EN60947-5-6, NAMUR), NO or NC and for NE or ND SPST relay output contact. Each channel enables a load to be controlled by a switch, or a proximity detector. Fault detection circuit (DIP switch configurable) is available for both proximity sensor and switch equipped with end of line resistors. In case of fault, when enabled it de-energizes the corresponding output relay and turns the fault LED on; when disabled the corresponding output relay repeats the input line open or closed status as configured. D6032D is programmable via dip switches as single input and two independent outputs. Out 2 can be programmed for output duplicating Out 1 or Fault detection Out. In case of duplication, relay actuation can be independently configured for each output. In case of fault output, relay actuation can be programmed as normally energized or normally de-energized. Presence of supply power and status of output (energized or de-energized), as well as integrity or fault condition of sensor and connecting line are displayed by signaling LEDs (green for power, yellow for status and red for fault condition).

**Note:** use of voltage free electrical contacts with fault detection enabled (control equipment) requires, near the switch at the end of the line a R1=1 K $\Omega$  typical (470  $\Omega$  to 2 K $\Omega$  range) resistor in series and a R2=10 k $\Omega$  typical (5 K $\Omega$  to 15 K $\Omega$  range) resistor in parallel to the contacts in order to allow the fault detection circuit to distinguish between a condition of contact close/open and a line open/short circuit fault.

## Installation

D6032 series are Switch/Proximity Detector Interface housed in a plastic enclosure suitable for installation on customized Termination Board. D6032 unit can be mounted with any orientation over the entire ambient temperature range. Electrical connection of conductors up to 2.5 mm<sup>2</sup> are accommodated by polarized plug-in removable screw terminal blocks which can be plugged in/out into a powered unit without suffering or causing any damage. The wiring cables have to be proportionate in base to the current and the length of the cable. On the section "Function Diagram" and enclosure side a block diagram identifies all connections. Identify the number of channels of the specific card (e.g. D6032S is a single channel model and D6032D is a dual channel model), the function and location of each connection terminal using the wiring diagram on the corresponding section, as an example:  
For Model D6032S, in case of Proximity or Voltage free Contact, connect the wires at terminal "7" for positive and "8" for negative.  
For Model D6032D in addition to channel 1 connections above, connect terminal "9" for positive and "10" for negative on channel 2.  
Connection for power supply and output are provided by Termination Board connector.

Connect SPST relay contacts checking the load rating to be within the contact maximum rating (100 mA 50 Vac 5 VA, 100 mA 50 Vdc 5 W (resistive load)). Units must be protected against dirt, dust, extreme mechanical (e.g. vibration, impact and shock) and thermal stress, and casual contacts. If enclosure needs to be cleaned use only a cloth lightly moistened by a mixture of detergent in water. Any penetration of cleaning liquid must be avoided to prevent damage to the unit. Any unauthorized card modification must be avoided. According to EN61010, D6032 series must be connected to SELV or SELV-E supplies.

## Start-up

Before powering the unit check that all wires are properly connected, particularly supply conductors and their polarity, input and output wires. Check conductors for exposed wires that could touch each other causing dangerous unwanted shorts. Turn on power, the "power on" green led must be lit, status and fault led on each channel must be in accordance with condition of the corresponding input line. If possible close and open input lines one at time checking the corresponding status and fault LEDs condition as well as output to be correct.

### D6032D used as double channel

A configuration DIP switch is located on component side of pcb. This switch allows the configuration of input/output relationship, fault detection functions and operating mode.

**WARNING:** dip-switch 6-7-8 must be set to "OFF" position.

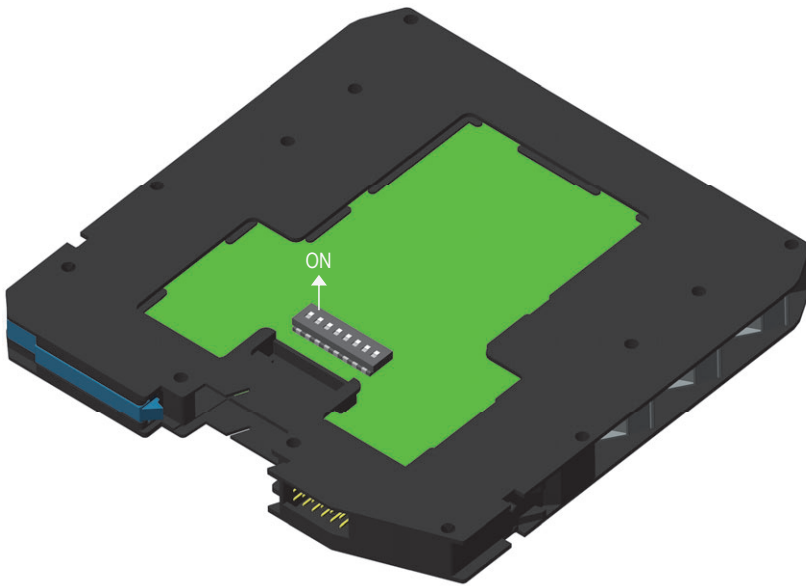

Dip switch factory settings. All Switches are OFF

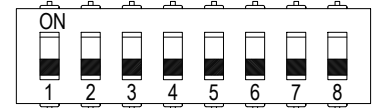

Dip switch configuration

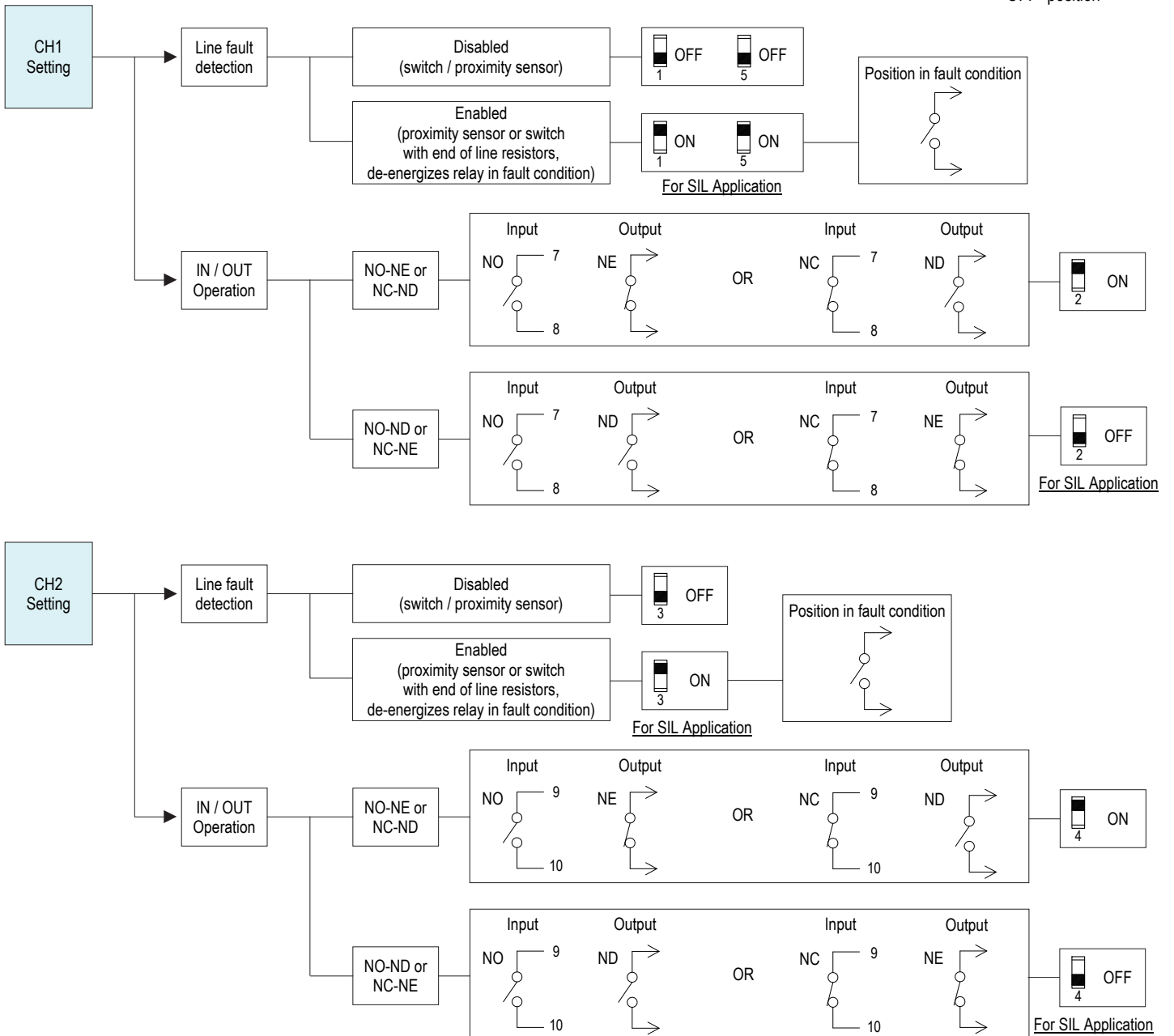
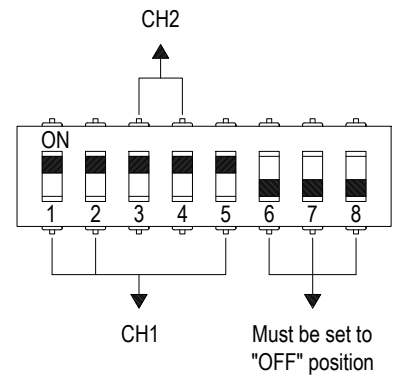

### D6032D used as duplicator or fault output

A configuration DIP switch is located on component side of pcb. This switch allows the configuration of input/output relationship, fault detection functions and operating mode.

**WARNING: Terminals 9-10 must be shorted to set module as Duplicator or Fault Out.  
Dip-switch 3 must be set to "OFF" position.**

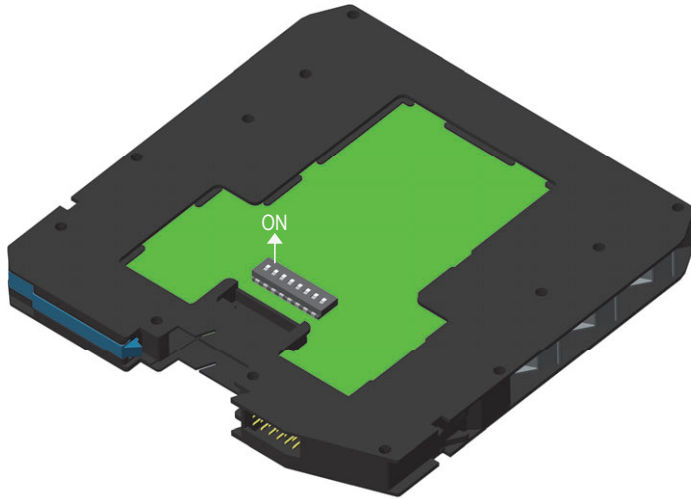

Dip switch factory settings. All Switches are OFF

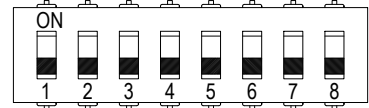

Dip switch configuration

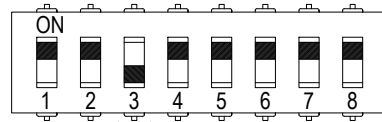

Must be set to "OFF" position

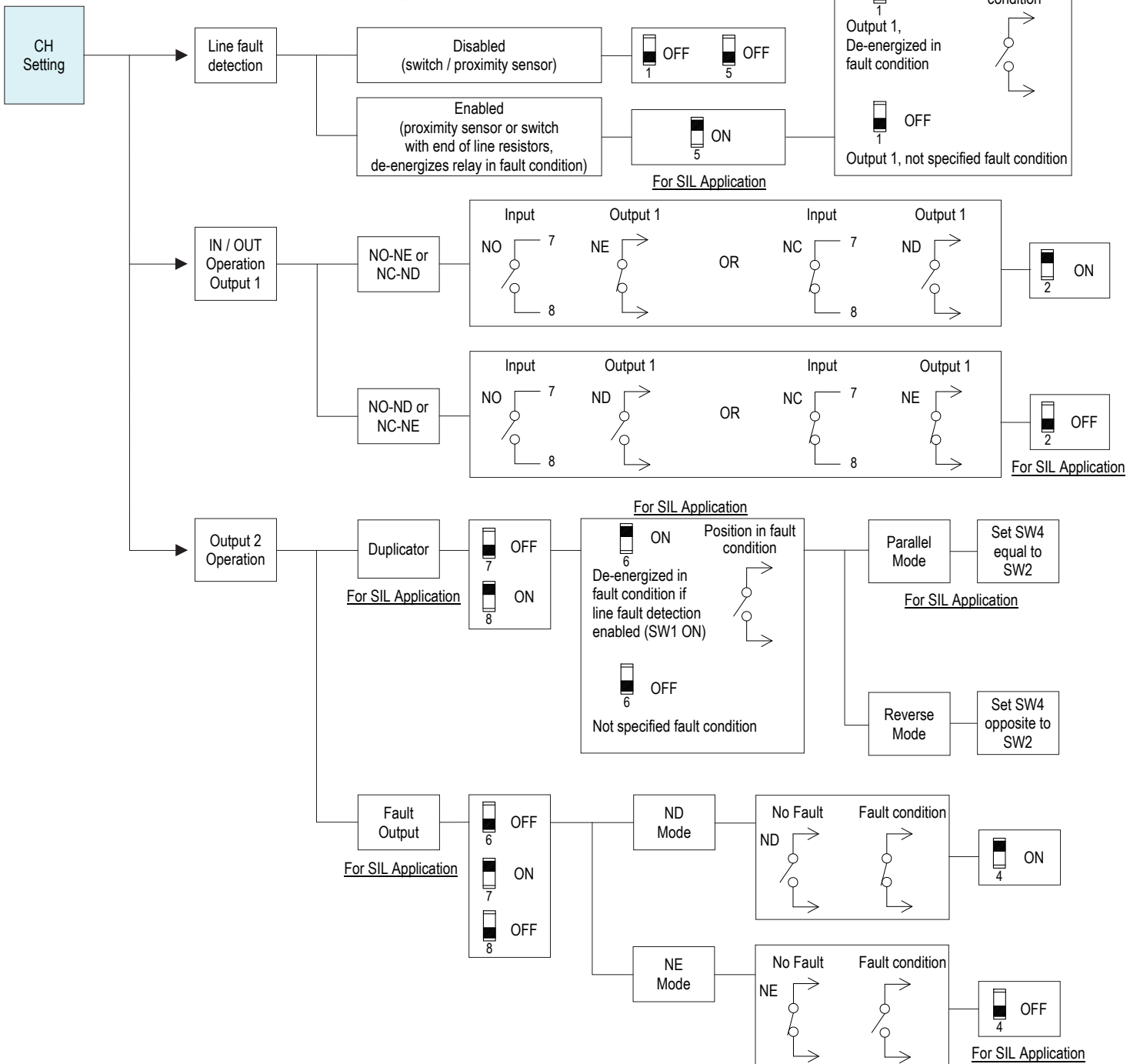

**D6032S**

A configuration DIP switch is located on component side of pcb. This switch allows the configuration of input/output relationship, fault detection functions and operating mode.

**WARNING:** Dip-switch 7-8 must be set to "OFF" position.

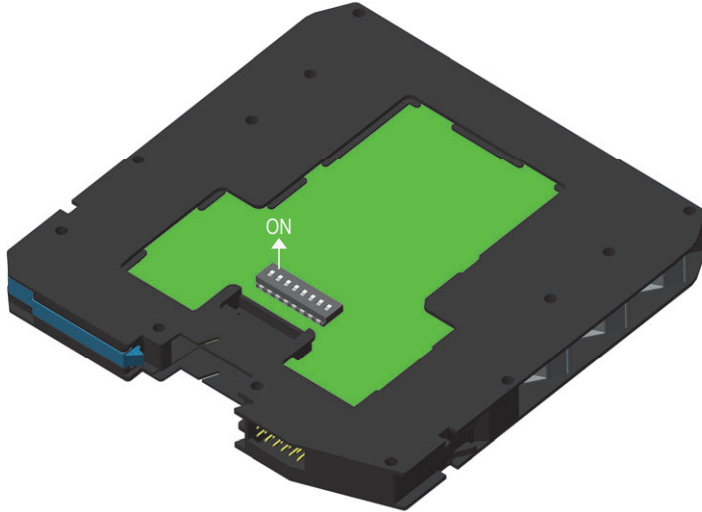

Dip switch factory settings. All Switches are OFF

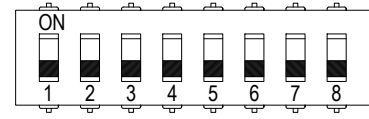

Dip switch configuration

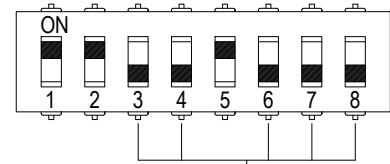

7-8 must be set to "OFF" position  
3-4-6 Not used

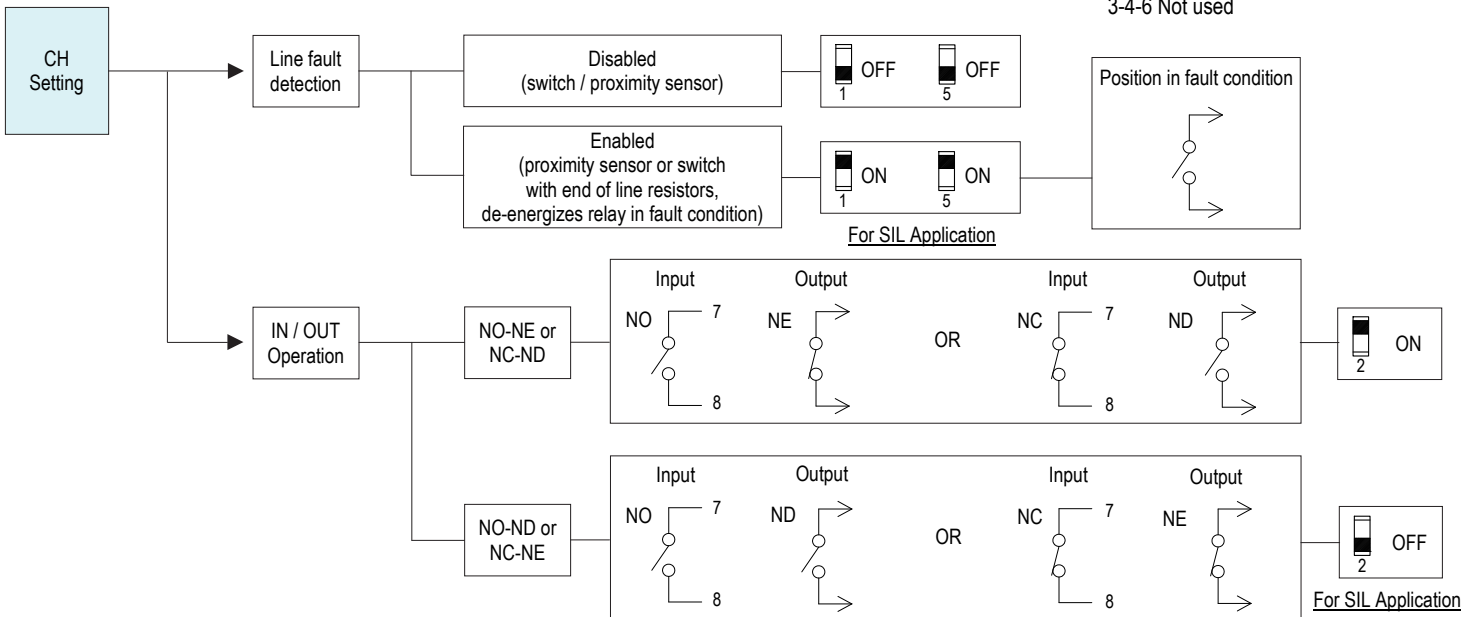



**DIP Switch factory settings (valid for D6032S and D6032D)**

SW1	SW2	SW3	SW4	SW5	SW6	SW7	SW8
OFF	OFF	OFF	OFF	OFF	OFF	OFF	OFF

**D6032D (used as double channel) Configuration Summary Table**

**WARNING:** dip-switch 6-7-8 must be set to “OFF” position.

Channel	1	2	Channel	1	2
Line fault detection	SW1	SW5	SW3	SW2	SW4
Disabled (switch/proximity sensor)	OFF	OFF	OFF	ON	ON
Enabled, <u>for SIL application</u> (proximity sensor or switch with end of line resistors, detects field open circuit and short circuit, de-energizes relay in fault condition)	ON	ON	ON	OFF	OFF

**D6032D (used as duplicator or fault output) Configuration Summary Table**

**WARNING:** Terminals 9-10 must be shorted to set module as Duplicator or Fault Out. Dip-switch 3 must be set to “OFF” position.

Line fault detection	SW1	SW5	IN/OUT Operation Output 1	SW2
Disabled (switch/proximity sensor)	OFF	OFF	NO-NE or NC-ND	ON
Enabled, <u>for SIL application</u> (proximity sensor or switch with end of line resistors, detects field open circuit and short circuit, de-energizes relay in fault condition)	Output 1, ( <u>for SIL application</u> ) De-energized in Fault condition	ON	NO-ND or NC-NE ( <u>for SIL application</u> )	OFF
	Output 1, Not specified Fault condition	OFF		

Output 2 Operation	SW6	SW7	SW8	Mode	SW4	
Duplicator	De-energized in fault condition ( <u>for SIL application</u> ) if line fault detection enabled (SW1 ON)	ON	OFF	ON	Parallel ( <u>for SIL application</u> )	Set equal to SW2
	Not specified Fault condition	OFF			Reverse	Set opposite to SW2
Fault Output	OFF ( <u>for SIL application</u> )	ON	OFF	ND	ON	
				NE ( <u>for SIL application</u> )	OFF	

**D6032S Configuration Summary Table**

**WARNING:** Dip-switch 7-8 must be set to “OFF” position.

Line fault detection	SW1	SW5	IN/OUT Operation	SW2
Disabled (switch/proximity sensor)	OFF	OFF	NO-NE or NC-ND	ON
Enabled, <u>for SIL application</u> (proximity sensor or switch with end of line resistors, detects field open circuit and short circuit, de-energizes relay in fault condition)	ON	ON	NO-ND or NC-NE ( <u>for SIL application</u> )	OFF